

GENERAL PURPOSE APPLICATION.
SWITCHING APPLICATION.

FEATURES

- A super-minimold package houses 2 transistor.
- Excellent temperature response between these 2 transistor.
- High pairing property in h_{FE} .
- The following characteristics are common for Q_1, Q_2 .

MAXIMUM RATING (Ta=25 °C)

CHARACTERISTIC	SYMBOL	RATING	UNIT
Collector-Base Voltage	V_{CBO}	60	V
Collector-Emitter Voltage	V_{CEO}	50	V
Emitter-Base Voltage	V_{EBO}	5	V
Collector Current	I_C	150	mA
Base Current	I_B	30	mA
Collector Power Dissipation	P_C^*	200	mW
Junction Temperature	T_j	150	°C
Storage Temperature Range	T_{stg}	-55 ~ 150	°C

* Total Rating

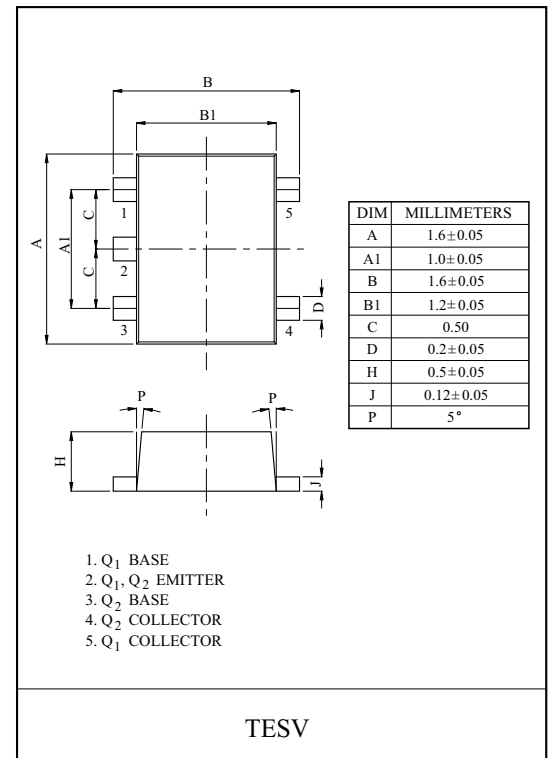

EQUIVALENT CIRCUIT (TOP VIEW)

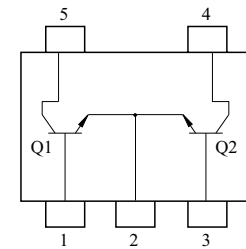

ELECTRICAL CHARACTERISTICS (Ta=25 °C)

CHARACTERISTIC	SYMBOL	TEST CONDITION	MIN.	TYP.	MAX.	UNIT.
Collector Cut-off Current	I_{CBO}	$V_{CB}=60V, I_E=0$	-	-	0.1	μA
Emitter Cut-off Current	I_{EBO}	$V_{EB}=5V, I_C=0$	-	-	0.1	μA
DC Current Gain	h_{FE} (Note)	$V_{CE}=6V, I_C=2mA$	120	-	400	
Collector-Emitter Saturation Voltage	$V_{CE(sat)}$	$I_C=100mA, I_B=10mA$	-	0.1	0.25	V
Transition Frequency	f_T	$V_{CE}=10V, I_C=1mA$	80	-	-	MHz
Collector Output Capacitance	C_{ob}	$V_{CB}=10V, I_E=0, f=1MHz$	-	2	3.5	pF
Noise Figure	NF	$V_{CE}=6V, I_C=0.1mA, f=1kHz, R_g=10k\Omega$	-	1.0	10	dB

Note : h_{FE} Classification Y(4):120 ~ 240, GR(6):200 ~ 400

Marking

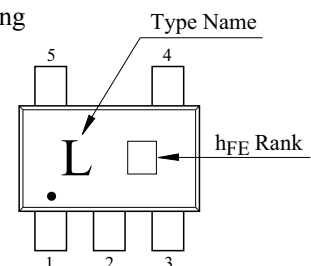

KTC601E

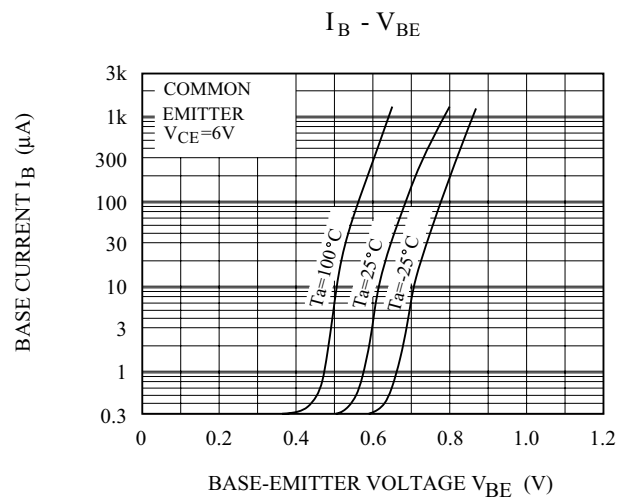
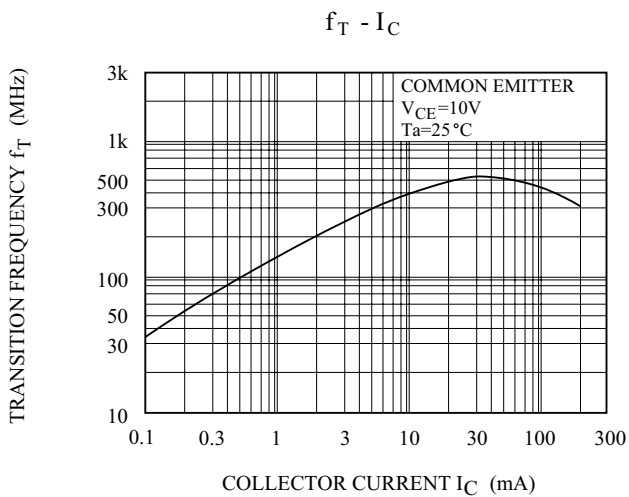
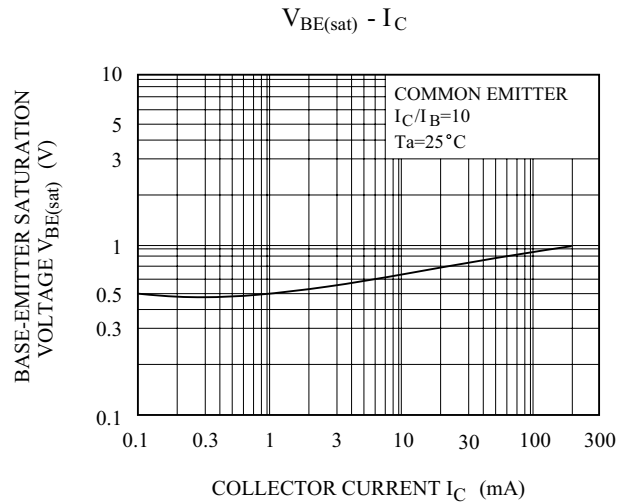
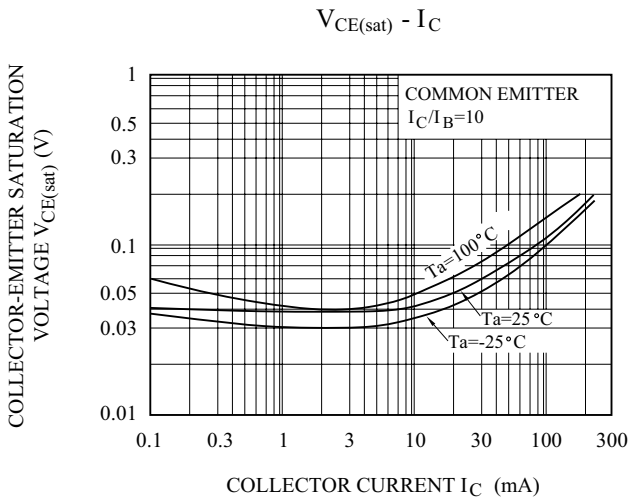
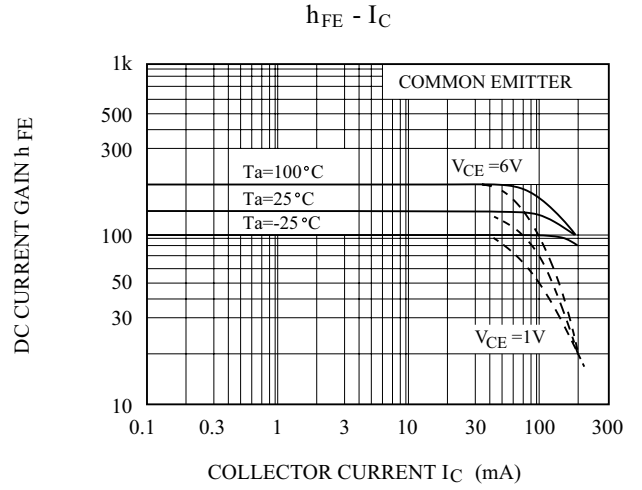
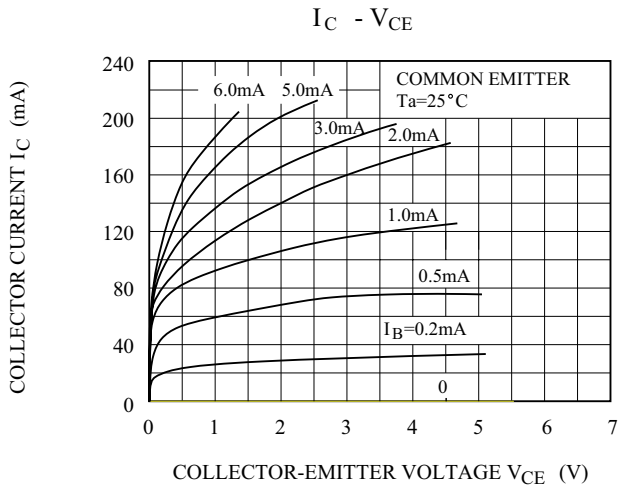

KTC601E

